

1A Sensitive SCRs

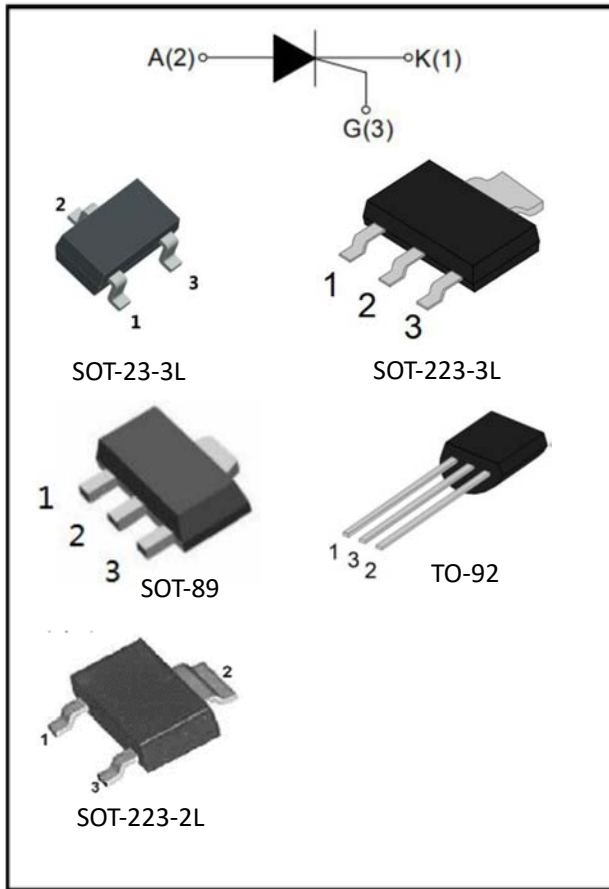

Features

- On-state rms current, $I_{T(RMS)}$ 1 A
- Repetitive peak off-state voltage, V_{DRM}/V_{RRM} 800 V
- Triggering gate current, I_{GT} 200 μ A

Applications

- Ground Fault Circuit Interrupters (GFCI)
- General purpose switching and phase control
- Ignition circuits, CDI
- Motor control - e.g. small kitchen appliances

Mechanical Data

- Case Material: "Green" Molding Compound
- Package:

| DEVICE | PACKAGE |
|----------|------------|
| YC0810S1 | SOT-23-3L |
| YC0810S2 | SOT-223 |
| YC0810S3 | SOT-89 |
| YC0810T9 | TO-92 |
| YC0810S4 | SOT-223-2L |

Main Characteristics

| SYMBOL | LIMITS | UNIT |
|-------------------|--------|---------|
| $I_{T(RMS)}$ | 1 | A |
| V_{DRM}/V_{RRM} | 800 | V |
| I_{GT} | 200 | μ A |

Maximum Ratings

| PARAMETER | SYMBOL | LIMITS | UNIT |
|---|---------------------|---------|------------------|
| Storage junction temperature range | T _{stg} | -40~150 | °C |
| Operating junction temperature range | T _j | -40~125 | °C |
| Repetitive surge peak Off-state voltage (T _j =25°C) | V _{DRM} | 800 | V |
| Repetitive peak reverse voltage (T _j =25°C) | V _{RRM} | 800 | V |
| RMS on-state current (T _C =80°C) | I _{T(RMS)} | 1 | A |
| Non-repetitive surge peak on-state current (half sine wave, t _p =10ms, T _j =25°C) | I _{TSM} | 8 | A |
| I ² t value for fusing (t _p =10ms) | I ² t | 0.5 | A ² s |
| Critical rate of rise of on-state current (I _G =2×I _{GT}) | di/dt | 50 | A/ μ s |
| Peak gate current | I _{GM} | 0.2 | A |
| Average gate power dissipation | P _{G(AV)} | 0.1 | W |
| Peak gate power | P _{GM} | 0.5 | W |



YC0810 Series

■Electrical Characteristics (T_a=25°C Unless otherwise specified)

| PARAMETER | SYMBOL | UNIT | TEST CONDITIONS | MIN | TYP | MAX |
|-----------------------------------|-----------------|------|---|-----|-----|-----|
| Gate trigger current | I _{GT} | μA | V _D =12V, R _L =33Ω | | 20 | 200 |
| Gate trigger voltage | V _{GT} | V | V _D =12V, R _L =33Ω | | 0.5 | 1.0 |
| Non-triggering gate voltage | V _{GD} | V | V _D =V _{DRM} T _j =110°C R _L =3.3kΩ | 0.2 | | |
| Holding current | I _H | mA | I _T =50mA | | | 2 |
| Latching current | I _L | mA | I _G =1.2 I _{GT} | | | 3 |
| Rate of rise of off-state voltage | dV/dt | V/μs | V _D =0.66×V _{DRM} T _j =110°C Gate open R _{GK} =1KΩ | 20 | | |

■Thermal Characteristics (T_a=25°C Unless otherwise specified)

| PARAMETER | SYMBOL | UNIT | TEST CONDITIONS | MAX |
|------------------------|-------------------|------|---|-----|
| Peak on-state voltage | V _{TM} | V | I _{TM} =1.4A t _p =380μS | 1.5 |
| Peak off-state current | I _{DRM} | μA | V _{DRM} = V _R RM, T _j =25°C, R _{GK} =1KΩ | 5 |
| Peak reverse current | I _R RM | mA | V _{DRM} = V _R RM, T _j =125°C, R _{GK} =1KΩ | 0.5 |

■Thermal Resistance (T_a=25°C Unless otherwise specified)

| PARAMETER | SYMBOL | UNIT | Pacakge | Value | |
|---------------------------------|------------------|-------------------|---------|--------------|----|
| Thermal Resistance (Typical) | Junction to case | R _{θj-c} | °C/W | TO-92/SOT-23 | 50 |
| | | | °C/W | SOT-89 | 28 |
| | | | °C/W | SOT-223 | 18 |



■ Characteristics (Typical)

FIG.1: Maximum power dissipation versus RMS on-state current

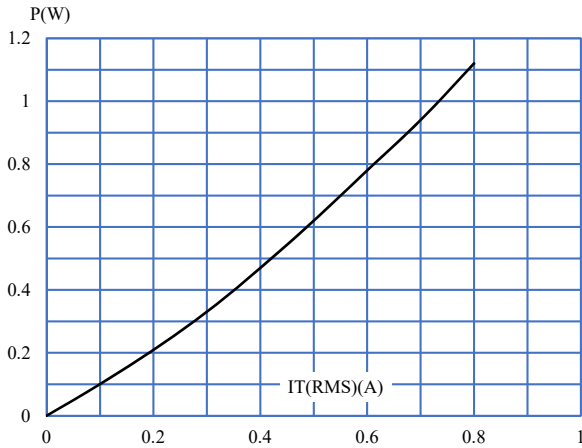

FIG.2: RMS on-state current versus case temperature

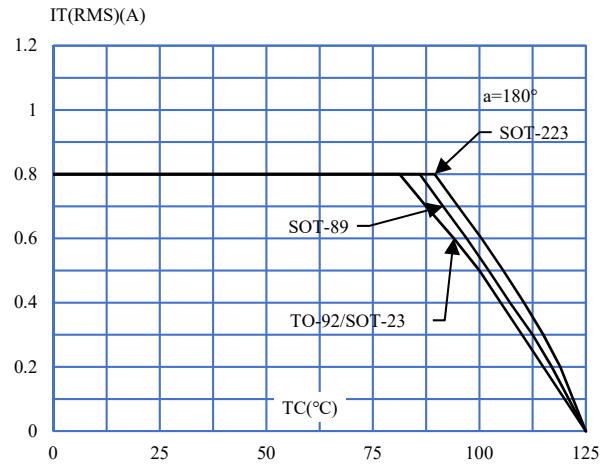

FIG.3: Surge peak on-state current versus number of cycles

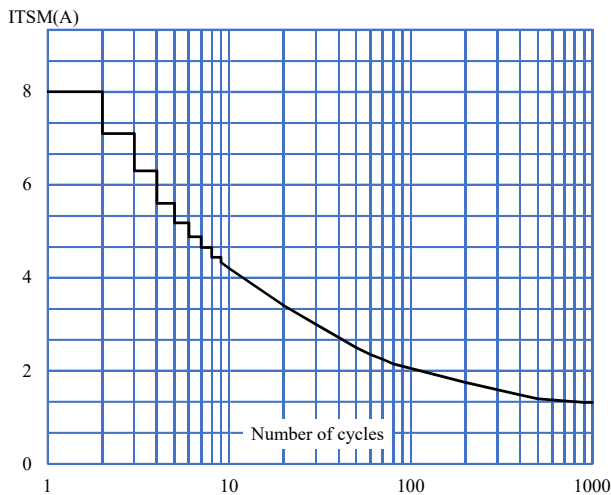

FIG.4: On-state characteristics (maximum values)

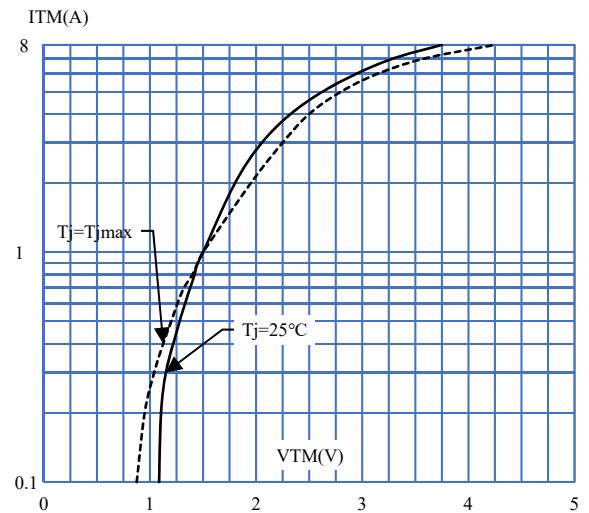

FIG.5: Non-repetitive surge peak on-state current for a sinusoidal pulse with width $t_p < 20\text{ms}$, and corresponding value of I^2t ($dI/dt < 50\text{A}/\mu\text{s}$)

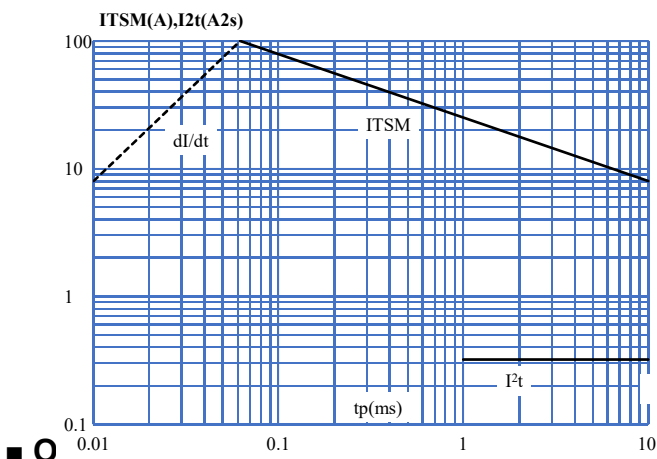
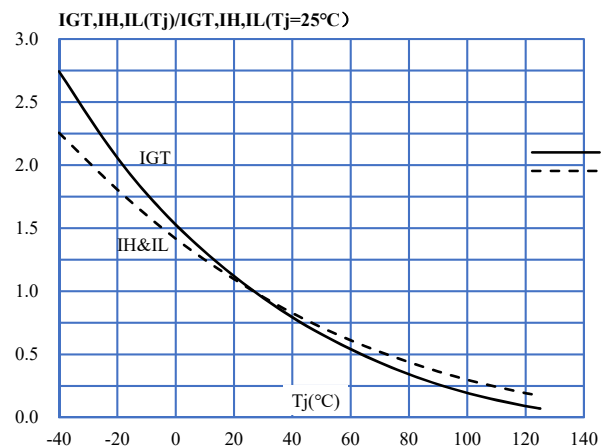

FIG.6: Relative variations of gate trigger current, holding current and latching





YC0810 Series

➤ SOT-23-3L Package Outline Dimensions

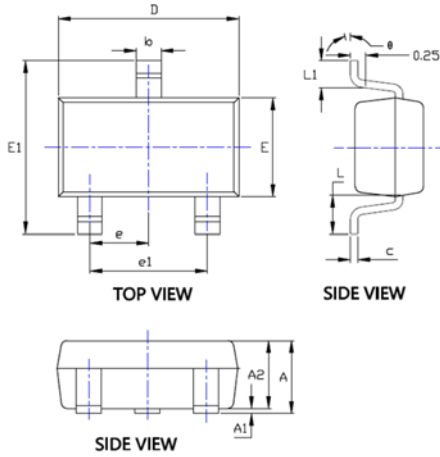

| SYMBOL | DIMENSIONS | | | |
|--------|------------|-------|------------|-------|
| | INCHES | | Millimeter | |
| | MIN. | MAX. | MIN. | MAX. |
| A | 0.041 | 0.049 | 1.050 | 1.250 |
| A1 | 0.000 | 0.008 | 0.000 | 0.200 |
| A2 | 0.041 | 0.045 | 1.050 | 1.150 |
| b | 0.012 | 0.020 | 0.300 | 0.500 |
| c | 0.004 | 0.008 | 0.100 | 0.200 |
| D | 0.111 | 0.119 | 2.820 | 3.020 |
| E | 0.059 | 0.067 | 1.500 | 1.700 |
| E1 | 0.104 | 0.116 | 2.650 | 2.950 |
| e | 0.037TYP | | 0.950TYP | |
| e1 | 0.071 | 0.079 | 1.800 | 2.000 |
| L | 0.024REF | | 0.600REF | |
| L1 | 0.012 | 0.024 | 0.300 | 0.600 |
| ∅ | 0° | 8° | 0° | 8° |

SOT-23-3L Suggested Pad Layout

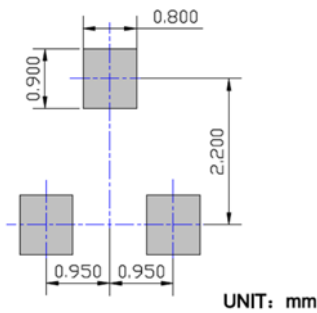

➤ SOT-223 Package Outline Dimensions

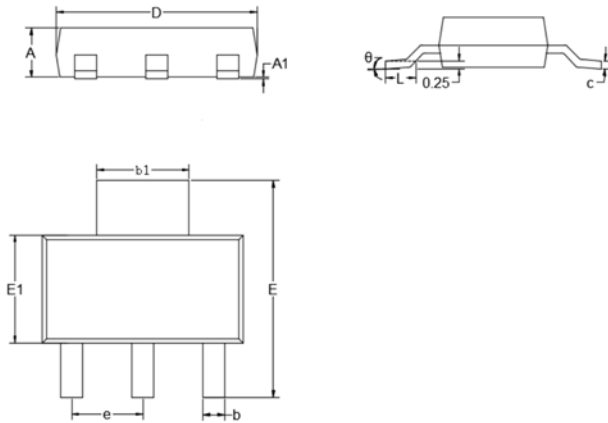

| DIM | DIMENSIONS | | | |
|-----|------------|--------|--------|--------|
| | INCHES | | MM | |
| | MIN | MAX | MIN | MAX |
| A | 0.0591 | 0.0670 | 1.5000 | 1.7000 |
| A1 | 0.0008 | 0.0039 | 0.0200 | 0.1000 |
| b | 0.0259 | 0.0330 | 0.6600 | 0.8400 |
| b1 | 0.1140 | 0.1220 | 2.9000 | 3.1000 |
| c | 0.0090 | 0.0138 | 0.2300 | 0.3500 |
| D | 0.2480 | 0.2640 | 6.3000 | 6.7000 |
| E | 0.2637 | 0.2874 | 6.7000 | 7.3000 |
| E1 | 0.1290 | 0.1460 | 3.3000 | 3.7000 |
| e | 0.0866 | 0.0945 | 2.2000 | 2.4000 |
| L | 0.0295 | 0.0492 | 0.7500 | 1.2500 |
| θ | 0° | 10° | 0° | 10° |

SOT-223 Suggested Pad Layout

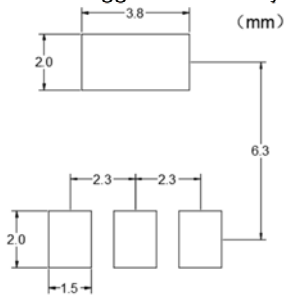

➤ SOT-89 Package Outline Dimensions



YC0810 Series

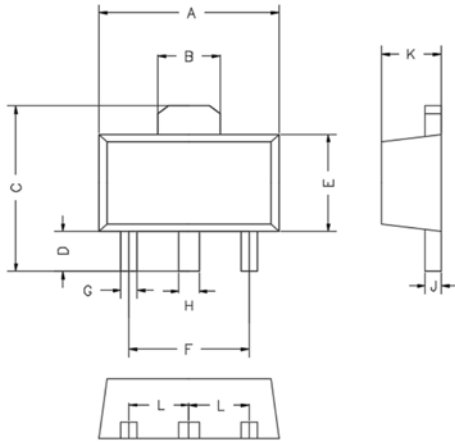

| DIM | DIMENSIONS | | | | NOTE |
|-----|------------|-------|------|------|------|
| | INCHES | | MM | | |
| | MIN | MAX | MIN | MAX | |
| A | 0.169 | 0.185 | 4.30 | 4.70 | |
| B | 0.061 | | 1.55 | | TYP |
| C | 0.154 | 0.171 | 3.91 | 4.35 | |
| D | 0.031 | 0.047 | 0.80 | 1.20 | |
| E | 0.089 | 0.104 | 2.25 | 2.65 | |
| F | 0.118 | | 3.00 | | TYP |
| G | 0.013 | 0.020 | 0.33 | 0.52 | |
| H | 0.016 | 0.023 | 0.40 | 0.58 | |
| J | 0.014 | 0.017 | 0.35 | 0.44 | |
| K | 0.055 | 0.063 | 1.40 | 1.60 | |
| L | 0.059 | | 1.50 | | TYP |

SOT-89 Suggested Pad Layout

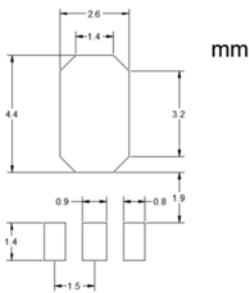

TO-92 Package Outline Dimensions

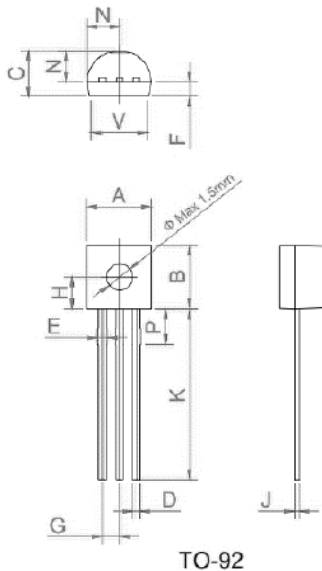

| Ref. | Dimensions | | | | | |
|------|-------------|------|-------|--------|-------|-------|
| | Millimeters | | | Inches | | |
| | Min. | Typ. | Max. | Min. | Typ. | Max. |
| A | 4.45 | 4.6 | 5.2 | 0.175 | 0.181 | 0.205 |
| B | 4.32 | 4.6 | 5.33 | 0.17 | 0.181 | 0.21 |
| C | 3.18 | 3.55 | 4.19 | 0.125 | 0.14 | 0.165 |
| D | 0.407 | | 0.533 | 0.016 | | 0.021 |
| E | 0.5 | | 0.7 | 0.020 | | 0.028 |
| F | - | 1.1 | - | - | 0.043 | - |
| G | - | 1.27 | - | - | 0.05 | - |
| H | - | 2.3 | - | - | 0.091 | - |
| J | 0.36 | 0.38 | 0.5 | 0.014 | 0.015 | 0.02 |
| K | 12.7 | | 15 | 0.5 | | 0.591 |
| N | 2.04 | 2.3 | 2.66 | 0.08 | 0.091 | 0.105 |
| P | 1.86 | | 2.06 | 0.073 | | 0.081 |
| V | | | 4.3 | | | 0.169 |

SOT-223-2L Package Outline Dimensions



YC0810 Series

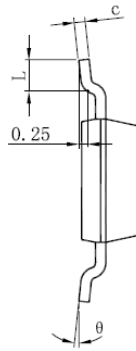
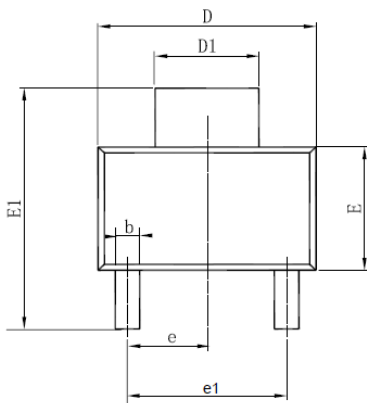

| Ref. | Dimensions | | | | | |
|------|--------------|--------|--------|-------------|------|------|
| | Inches | | | Millimeters | | |
| | Min. | Typ. | Max. | Min. | Typ. | Max. |
| A | | | 0.0709 | / | / | 1.80 |
| A1 | 0.00079 | | 0.0039 | 0.02 | / | 0.10 |
| A2 | 0.0591 | 0.063 | 0.0667 | 1.50 | 1.60 | 1.70 |
| b | 0.026 | 0.028 | 0.0331 | 0.66 | 0.71 | 0.84 |
| c | 0.0091 | 0.0118 | 0.0138 | 0.23 | 0.30 | 0.35 |
| D | 0.248 | 0.256 | 0.264 | 6.30 | 6.50 | 6.70 |
| D1 | 0.114 | 0.118 | 0.122 | 2.90 | 3.00 | 3.10 |
| E | 0.13 | 0.138 | 0.146 | 3.30 | 3.50 | 3.70 |
| E1 | 0.264 | 0.276 | 0.287 | 6.70 | 7.00 | 7.30 |
| e | 0.0906 BASIC | | | 2.30 BASIC | | |
| e1 | 0.181 BASIC | | | 4.60 BASIC | | |
| L | 0.0295 | / | / | 0.75 | / | / |
| θ | 0° | / | 10° | 0° | / | 10° |

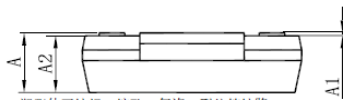

■ Marking Information

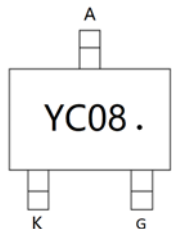

YC0810S1
(SOT-23 Package)

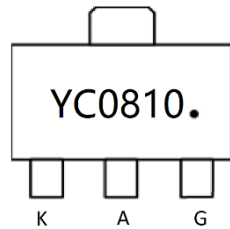

YC0810S2
(SOT-223-3L Package)

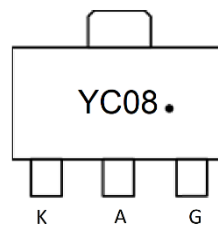

YC0810S3
(SOT-89 Package)

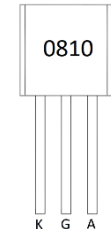

YC0810T9
(TO-92)

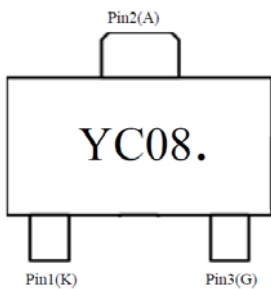

YC0810S4
(SOT-223-2L Package)

Disclaimer



YC0810 Series

The information presented in this document is for reference only. Yangzhou Yangjie Electronic Technology Co., Ltd. reserves the right to make changes without notice for the specification of the products displayed herein to improve reliability, function or design or otherwise.

The product listed herein is designed to be used with ordinary electronic equipment or devices, and not designed to be used with equipment or devices which require high level of reliability and the malfunction of which would directly endanger human life (such as medical instruments, transportation equipment, aerospace machinery, nuclear-reactor controllers, fuel controllers and other safety devices), Yangjie or anyone on its behalf, assumes no responsibility or liability for any damages resulting from such improper use of sale.

This publication supersedes & replaces all information previously supplied. For additional information, please visit our website [http:// www.21yangjie.com](http://www.21yangjie.com) , or consult your nearest Yangjie's sales office for further assistance.